



100 1162



120 1162



135 1166

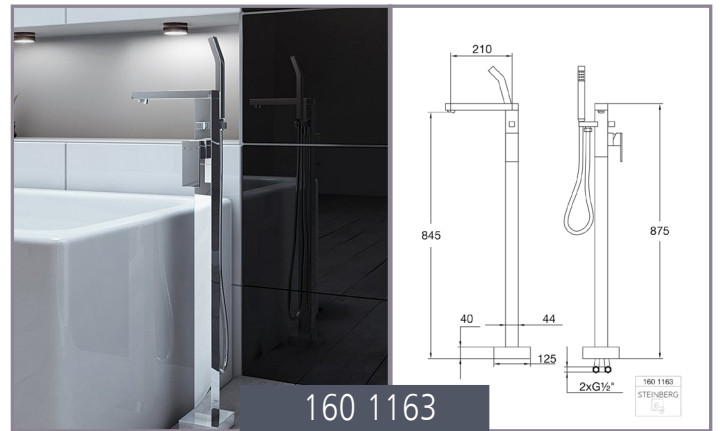

160 1163

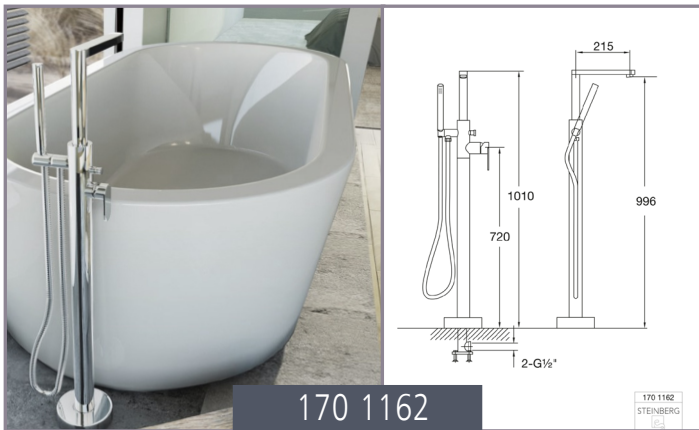

170 1162

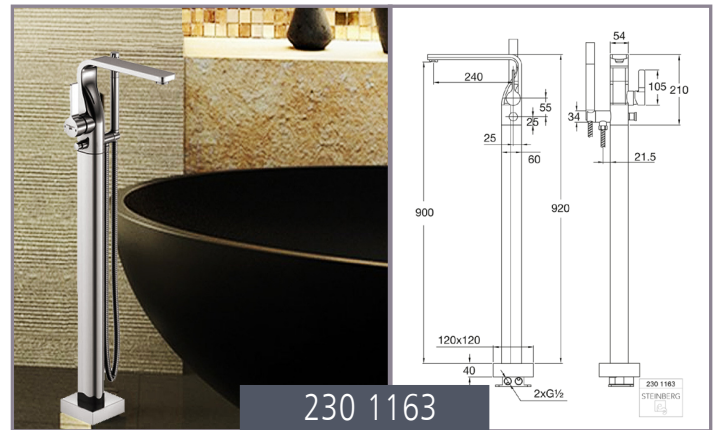

230 1163



250 1162



260 1162