

SYSTEMS of RUBEN Whirlpool

WARRANTY
INSTALLATION INSTRUCTIONS
USAGE
MAINTANANCE

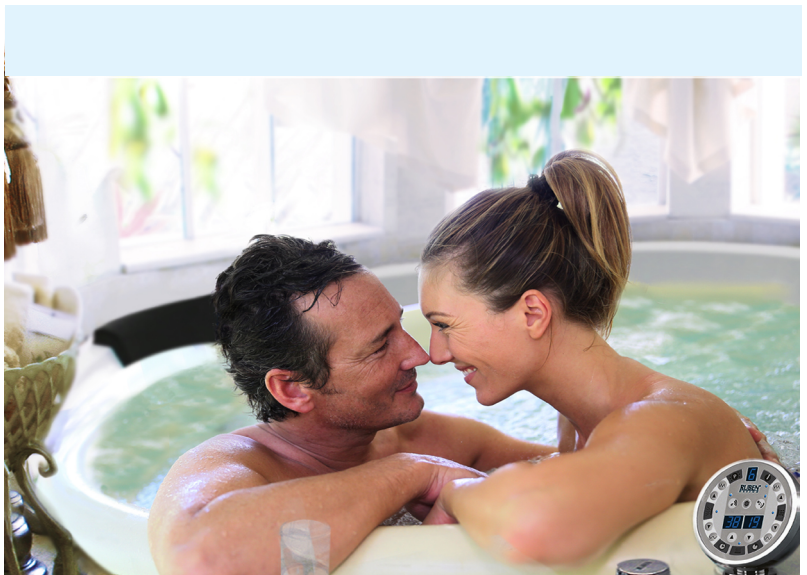

RUEN

RUBEN

WARRANTY TERMS

1. This warranty is valid as long as usage and installation have followed the procedures within this manual. The warranty period for hydromassage systems is 24 months from the date of purchase. The warranty is valid for 30 months after being issued by RUBEN DESIGN, it expires automatically if damage has originated from the following causes:

- improper connection of electric installation and nonobservance of the assembly instructions,
- dirt accumulation in jets and suction
- excessive lime in the water supply
- use of improper cleaning agents
- unauthorised repairs
- use of the bathtub with disregard to operating instructions,
- mechanical damages
- power network damage or power fluctuations.

2. The customers are asked to place objections in the place of purchase or with the Ruben Design service

3. All defects will be removed free of charge within 30 days by either repairing or replacement of faulty components (this does not include light bulbs)

4. Should a damage occur on which no guarantee is granted all cost of repairs and service visit are covered by the customer.

5. Guarantee card must be filled out on the day of delivery and is valid only with the receipt as well as technical acceptance and bathtub connection certificate.

6. All warranty repairs documentation is made out by the servicing personel and signed by the customer.

7. Duplicates of guarantee card will not be issued.

8. Customer's signature on coupon 'B' means acceptance of guarantee conditions.

ATTENTION! Please allow adequate service access to all hydro-massage system components. The warranty does not cover defects or damage to the bathtub shell caused by user or other person.



WARRANTY COUPON "A" NO.

MODEL

HYDROMASSAGE SYSTEM

SERIAL NUMBER

PUMP NUMBER

BLOWER NUMBER

ADDITIONAL EQUIPMENT

.....

SELLER.....

DATE PURCHASED

Purchased From (stamp and signature)

WARRANTY COUPON "B" NO.

MODEL

HYDROMASSAGE SYSTEM

SERIAL NUMBER

PUMP NUMBER

BLOWER NUMBER

ADDITIONAL EQUIPMENT

.....

SELLER

DATE PURCHASED

Purchased From (stamp and signature)

Customer's Full Name

Customer's Signature

Customer's Address



Technical Control Certificate

1. Leak Test

Result

POSITIVE

Name and Signature of the Employee

2. Electrical test - in compliance with IEC 335-1

Result

POSITIVE

Name and Signature of the Employee

3. Connections Certificate

The bathtub has been connected to water and power supply in accordance with the installation instructions and tested for safety - IEC-60364/41 61 .



Address

Stamp and Signature



RUBEN
SYSTEM

RUBEN
SYSTEM

RUBEN
SYSTEM

RUBEN
SYSTEM

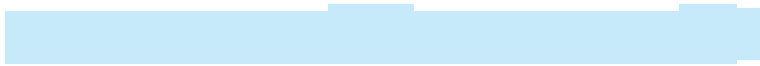

ASSEMBLY INSTRUCTIONS

Date manufactured	Manufacturer's Stamp and Signature
-------------------	------------------------------------

BATHTUB WITH HYDROMASSAGE - TECHNICAL DATA

All RUBEN DESIGN hydromassage systems have a safety certificate



XSYSTEM

XElectrical Parameters

Rated Voltage 220-230 V ~
Rated Power W

Level of Protection IPX 5
Overheat Protection - Built-in Thermal Fuse

XBATHTUB

.....

XBATHTUB FINISH COLOUR.....

XACCESORIES FINISH COLOUR

XJets (kinds and quantity): AIR JETS: 3-hole, 5-hole, 7-hole.....,

Water Super-Jet, Rotary Water Super-Jet, Shiatsu Water-Jet,

Water MAX-jet....., Rotary Water MAX-jet.....

XOptions: Aromatherapy, Lighting, Disinfection, Heating,

XNotes:.....

General considerations

◀ **Transportation:** Bath units with hydromassage system are delivered in specially deigned containers. Prior to installation the contents must be inspected for shipping damages or shortages. The bath can only be handled by the shell or frame.

Under no circumstances is it permitted to lift or hold the unit by the pipes, cables and other components of the hydromassage system. Please read the instruction manual before operating the unit.

◀ **Drain and water supply installation** ought to be done in compliance with local codes and standards. Water can be supplied from either a tub or wall mounted faucet. The disinfection system is fed from a seperate cold water lateral connection 1/2".

◀ **ATTENTION - disinfection line connector must be placed inside the bathroom within the unit outline under its upper edge.**

The connection is fitted with an electromagnetic valve controlled by water-level sensor. To trap impurities in the water flow a strainer is placed inside - it should be checked regularly for accumulation of dirt and, if it occurs, the strainer ought to be cleaned or replaced.



Electrical connections set-up

All wiring must be performed by a licensed electrician in accordance with all local codes and the national electrical code. Bath-tub must be connected to the electric circuit permanently, i.e. without plugs and sockets. Connect equipotential bonding bar with safety clamps. After completing the connections installer should carry out the standard check up insulation and anti-electric shock systems. Part of the system working under 230 V can not be exposed to contact during the use of the bay **Ruben Design** recommends annual insulation and anti-electric shock check ups .

After completing the installation electrician must fill the Technical Control Certificate

The distribution board has to be protected by a 30 mA RCD and a circuit breaker.

The bathtub frame must be earthed.

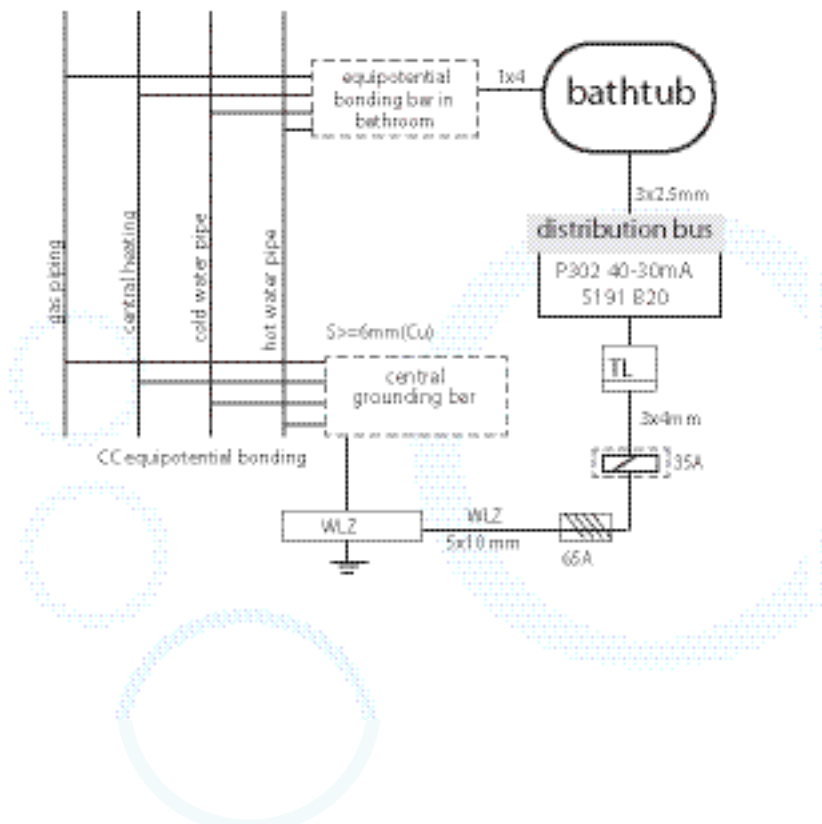

BATH-TUB INSTALLATION

⚠ Prior to set up inspect the bath-tub and hydromassage system for shipping damages and shortages as well as read the manual and Technical Control Certificate.

MANUFACTURER WILL BE HELD NO LIABLE FOR ANY COSTS OF DAMAGES OCCURRED DURING INSTALLATION.

1. The floor must be finished and leveled. Appropriate drainage system and cold/hot water connections must be ready. Room has efficient ventilation.

2. Put the bathtub in the right place. Rotating baths feet to level bath-tub off and secure it with counter screw. Always rest the level on the edge, never on the bottom of the bath (1). Make sure that all the feet rest on the floor.

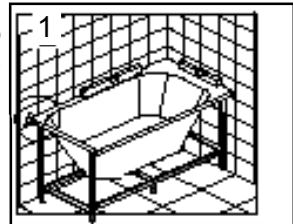

3. Mark the level off the bath on the adjoining wall(s) (2-3a).

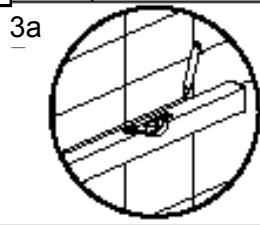
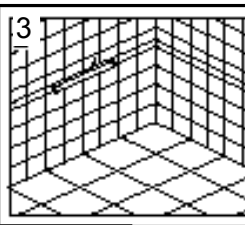
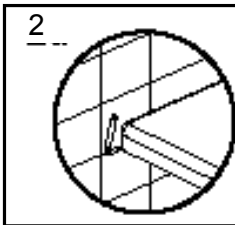

4. Fix the supporting wooden bar (not provided) (4). Length of the bar should be 5 mm shorter than bath-tub edge

5. Fix two hangers at both ends of the supporting bar. (5-6a). Position the bath-tub in the desire place, fill it with the water before fixing it on the hangers

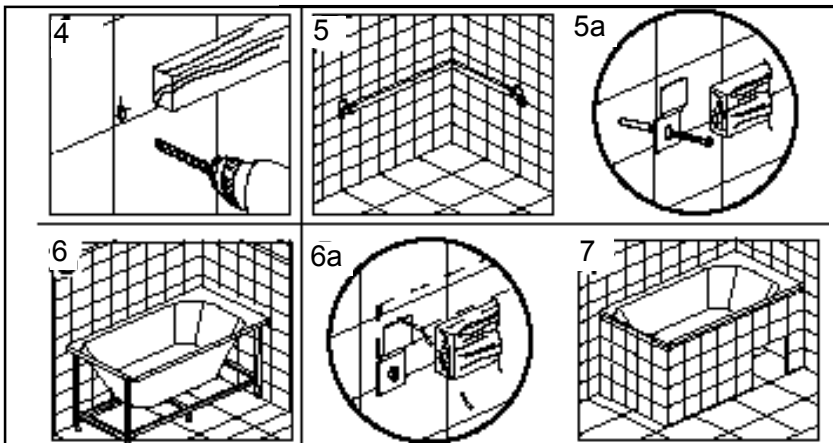

Leak check up of the bath

Fill the bath-tub with water above the water jets and wait 45 minutes then run the system for 20 minutes to check its operations

❖ Bath-tub can be fix permanently only after the successful leak test

Framing

Framing can be done as either

1. removable acrylic front panel/skirt/ as offered by Ruben Design

Removable acrylic front panel is delivered ready for installation. If the walls turn out to be slightly uneven at the place where they are met by the bath, the skirt can be trimmed with a fine saw or sharp knife. Spring clamps should be attached to wooden blocks underneath the lip of the bath, the two central blocks have metal sup-ports with levelling feet screwed on to them. Slide upper side of skirt between the clamps and the lip of the bath. Check again whether the bath unit remains level with the floor .

correct way to fix bathtub to the wall

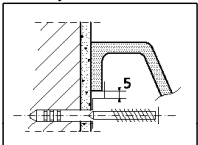

incorrect way to fix bathtub to the wall

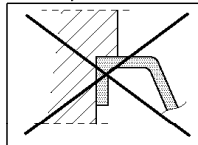

fixing FRONT PANEL of the bathtub - DETAIL A

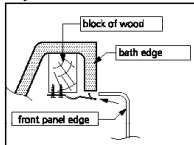

fixing FRONT PANEL of the bathtub - DETAIL B

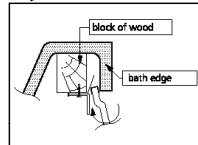

fixing FRONT PANEL of the bathtub - DETAIL C

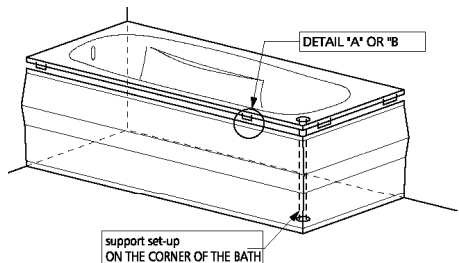
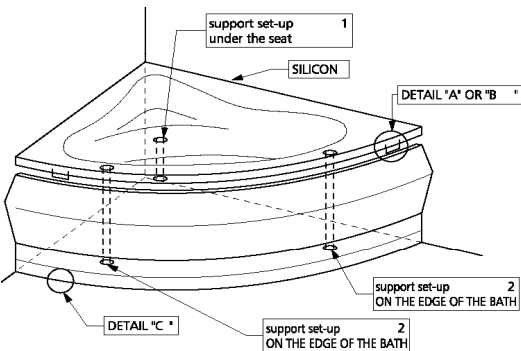
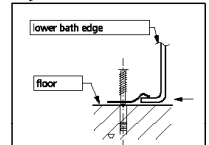

2. individual enclosure (ceramic tiles, panel)

Provide adequate area around unit for service access to hydromassage system components. Make sure the unit can be removed by lifting upward. Allow a space of 3 mm between the bath and the wall. After finishing the space should be filled with silicon caulk (the unit filled with water) and left until it sets.

Caution:

1. the floor covering under the unit should be capable of absorbing vibrations (eg.: a layer of silicon rubber)
2. provide access area of at least 20x40 cm for drain trap connection
3. during installation protect system components and connections from soiling with plaster, grout, adhesive, etc.
4. Air ducts should be protected by a grate 15 x 15 cm
5. make sure there is sufficient air space for ventilation around and underneath the unit..

It is recomendet to use slading enclosure from under bath-tub.

It i made out of e.g. aluminium frame and tiled plaster bord

EXTERIOR FINISH

Framing can be done as either

1. removable acrylic skirt or
2. permanent enclosure (ceramic tiles, panels, itp.).

Removable skirt

A removable skirt is ready for installation. If the walls turn out to be slightly uneven at the place where they are met by the bath, the skirt can be trimmed with a fine saw or sharp knife. Spring clamps should be attached to wooden blocks underneath the lip of the bath, the two central blocks have metal supports with levelling feet screwed on to them. Slide upper side of skirt between the clamps and the lip of the bath. Check again whether the bath unit remains level with the floor.

Permanent enclosure

- ❖ Provide adequate area around unit for service access to hydromassage system components.
- ❖ Make sure the unit can be removed by lifting upward.
- ❖ Allow a space of 3 mm between the bath and the wall.

After finishing the space should be filled with silicon caulk (the unit filled with water) and left until it sets.

❖ Caution:

1. the floor covering under the unit should be capable of absorbing vibrations (eg.: a layer of silicon rubber)
2. provide access area of at least 20 x 40 cm for drain trap connection
3. during installation protect system components and connections from soiling with plaster, grout, adhesive, etc.
4. Air ducts should be protected by a grate 15 x 15 cm
5. make sure there is sufficient air space for ventillation around and underneath the unit.



RUBEN-NEOSDIGITAL

1. AIR / WATER SYSTEM BUTTONS

a) SYSTEM ACTIVATED

- **short press**; system *on/off*
- **hold down >3 secs.**; activation of pulsating mode - 3,5/3,5 sec. cycles

b) SYSTEM DE-ACTIVATED

- **short press**; automatic disinfection (option) / drying *off*
- **hold down >3 secs.**; automatic functions activation

2. TIME SETUP BUTTON

a) SYSTEM ACTIVATED

- **1st short press**; display of time required for the system to turn off. When the button is pressed during time display it will not be recognised by the system (time setup while the system is on through successive presses at < 3 sec. intervals)
- **short press**: time change at 5 min. steps (range 5 to 30 min.)

3. UNDERWATER LIGHT BUTTON

a) SYSTEM ACTIVATED

- **short press**; *on/off*
- **hold down >3 secs.**; activation of pulsating mode - 3,5/3,5sec. cycles

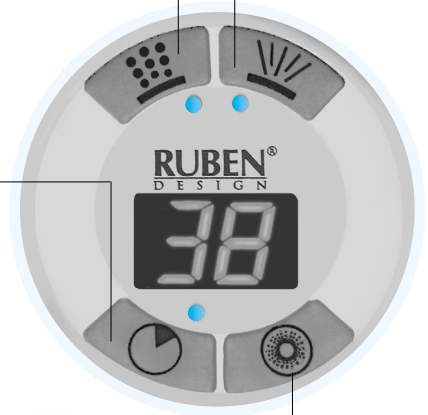

type basic

RUBEN-TITAN DIGITAL

1. WATER SYSTEM BUTTON

a) SYSTEM ACTIVATED

■ **short press**; system *on/off*

■ **hold down >3 secs.**; activation of pulsating mode - 3,5/3,5 sec. cycles.

b) SYSTEM DE-ACTIVATED

■ **short press**; activated automatic disinfection (option) *off*

■ **hold down >3 secs.**; automatic disinfection (option) *on*

2. TIME SETUP BUTTON

a) SYSTEM ACTIVATED

■ **1st short press**; display of time required for the system to turn off. When the button is pressed during time display it will not be recognised by the system (time setup while the system is on through successive presses at < 3 sec. intervals)

■ **short press**; time change at 5 min. steps (range 5 to 30 min.)

3. UNDERWATER LIGHT BUTTON

a) SYSTEM ACTIVATED

■ **short press**; *on/off*

■ **hold down >3 secs.**; activation of pulsating mode - 3,5/3,5sec. cycles.

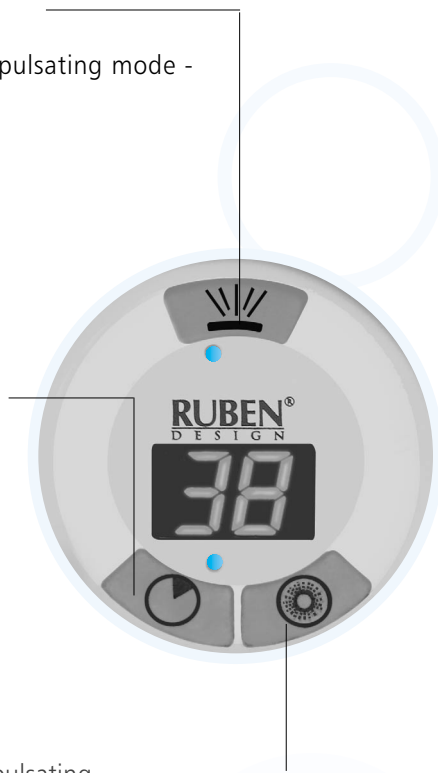

RUBEN-REXUSDIGITAL

1. AIR SYSTEM BUTTON

- a) SYSTEM ACTIVATED
 - **short press**; system *on/off*
- b) SYSTEM DE-ACTIVATED
 - **short press**; activation of automatic drying (option)
 - **hold down >3 secs.**; automatic functions activation

3. BLOWER OUTPUT BUTTON

- DEFAULT OUTPUT SET AT 8.
RANGE 1-12
- **short press**; default value 8 displays. A dot in the upper left corner signals the blower output setup mode, each successive press causes output to decrease until it reaches lowest value, then it starts to increase. Press and hold down - change of increase / decrease mode.

4. SINUSOIDAL/PULSATING MODE SELECTION BUTTON

- **1st short press**; sinusoidal mode *on*, **2nd short press** - pulsating mode *on*. The functions are switched alternately. Pressing the output button will terminate selection mode and the system will return to the default value 8.

5. HYDROMASSAGE TIMER BUTTON

- a) SYSTEM ACTIVATED
 - **1st short press**; display of time required for the system to turn off. When the button is pressed during time display it will not be recognised by the system (time setup while the system is on through successive presses at < 3 sec. intervals)
 - **short press**; time change at 5 min. steps (range 5 to 30 min.)

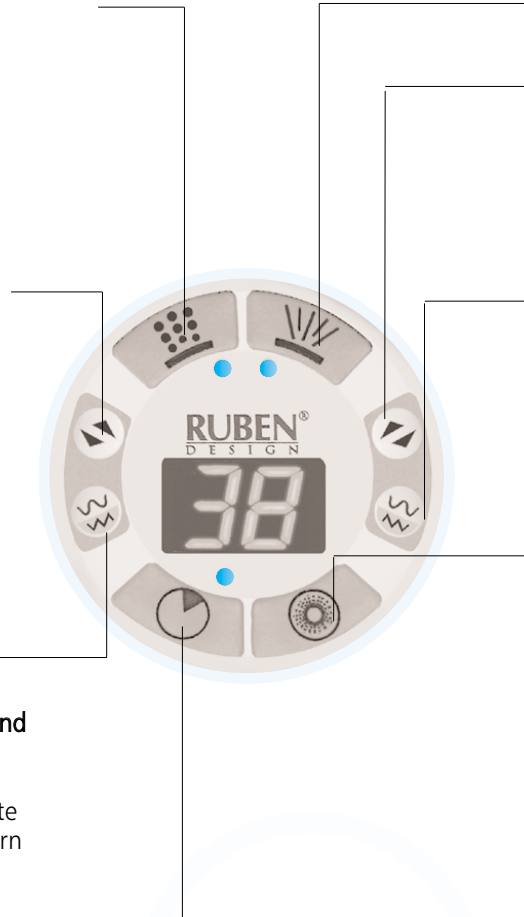

6. WATER SYSTEM BUTTONS

- a) SYSTEM ACTIVATED ■ **short press**; system *on/off*
b) SYSTEM DE-ACTIVATED ■ **short press**; automatic disinfection (option) *off*
■ **hold down >3 secs.**; automatic functions *on*

7. BLOWER OUTPUT BUTTON

DEFAULT OUTPUT VALUE SET AT 8. RANGE 1-12

- **short press**; default value (8) displays. A dot in the upper left corner signals the blower output set-up mode, each successive press causes output to decrease until it reaches the lowest value, then it starts to increase.
Press and hold down - change of increase / decrease mode.

8. SINUSOIDAL/PULSATING MODE SELECTION BUTTON

- **1st short press**; sinusoidal mode *on*, **2nd short press**; interval mode *on* - the functions are switched alternately.
Pressing the output button will terminate selection mode and the system will return to the default value 8.

9. UNDERWATER LIGHT BUTTON

- a) SYSTEM ACTIVATED ■ **short press**; *on/off* ■ **hold down >3 secs**;
activation of pulsating mode - 3,5/3,5sec. cycles

RUBEN-REXUS *Champagne*

CHAMPAGNE HYDROMASSAGE

The hydromassage system is activated by turning on the pump and the blower and directing water stream (through water diverter) towards the system of champagne jets.

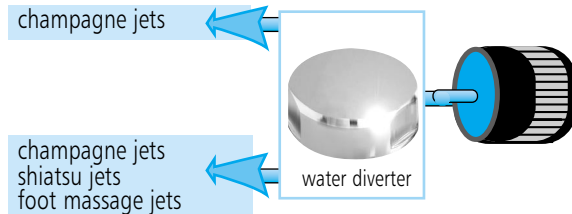

RUBEN-KENZO DIGITAL

1. WATER SYSTEM BUTTONS

- a) SYSTEM ACTIVATED
 - **short press**; system *on/off*
- b) SYSTEM DE-ACTIVATED
 - **short press**; automatic disinfection (option) *off*
 - **hold down >3 secs**; disinfection *on*

3. PUMP OUTPUT INCREASE / DECREASE

DEFAULT OUTPUT VALUE SET AT 8. RANGE 1-12

- **short press**; display of default output value 8.
- A dot in the upper left corner signals the blower output setup mode, each successive press will cause the output to increase/decrease within the specified min./max. range.

4. SINUSOIDAL MODE BUTTON

- **short press**; function *on/off*

5. PULSATING MODE BUTTON

- **short press**; function *on/off*

6. TIME SETUP BUTTON

- a) SYSTEM ACTIVATED
 - **1st short press**; display of time required for the system to turn off. When the button is pressed during time display it will not be recognised by the system (time set-up while the system is on through successive presses at < 3 sec. intervals)
 - **short press**; time change at 5 min. steps (range 5 to 30 min.)

9. UNDERWATER LIGHT BUTTON

- a) SYSTEM ACTIVATED
 - **short press**; *on/off*
 - **hold down >3 secs**; activation of pulsating mode - 3,5/3,5sec. cycles

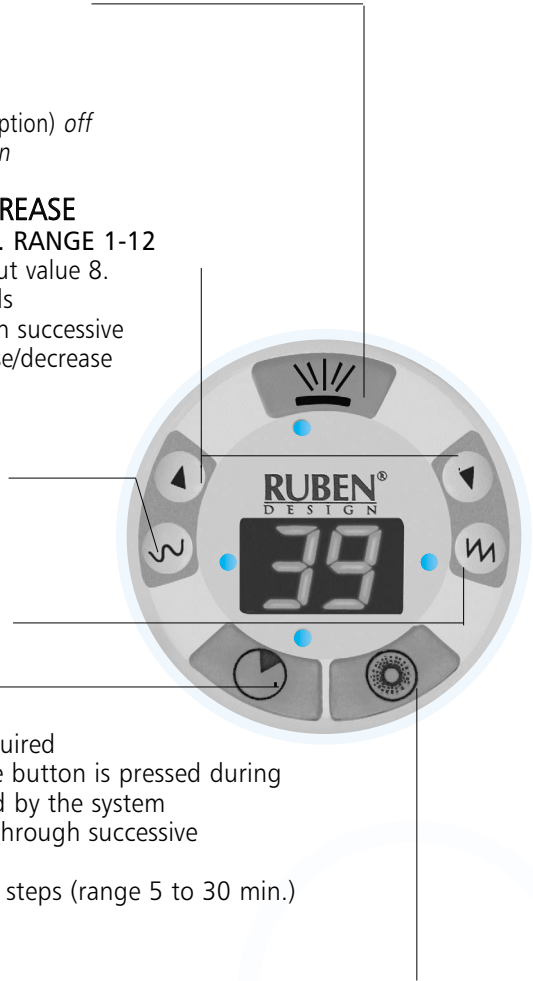

RUBEN-AJAXDIGITAL

1. AIR SYSTEM BUTTONS

- a) SYSTEM ACTIVATED
 - **short press**; system *on/off*
- b) SYSTEM DE-ACTIVATED
 - **short press**; drying *off*
 - **hold down >3 secs.**; drying *on*.

3. BLOWER OUTPUT BUTTON - INCREASE/DECREASE

DEFAULT OUTPUT VALUE SET AT 8. RANGE 1-12

- **short press**; display of default output value 8.
- A dot in the upper left corner signals the blower output setup mode, each successive press will cause the output to increase/decrease within the specified min./max. range..

4. SINUSOIDAL MODE BUTTON

- **short press**; function *on/off*

5. PULSATING MODE BUTTON

- **short press**; function *on/off*

6. TIME SET-UP

- a) SYSTEM ACTIVATED
 - **1st short press**; display of time required for the system to turn off. When the button is pressed during time display it will not be recognised by the system (time set-up while the system is on through successive presses at < 3 secs. intervals)
 - **short press**; time change at 5 min. steps (range 5 to 30 min.)

9. UNDERWATER LIGHT BUTTON

- a) SYSTEM ACTIVATED
 - **short press**; *on/off*
 - **hold down >3 secs.**; activation of pulsating mode - 3,5/3,5sec. cycles

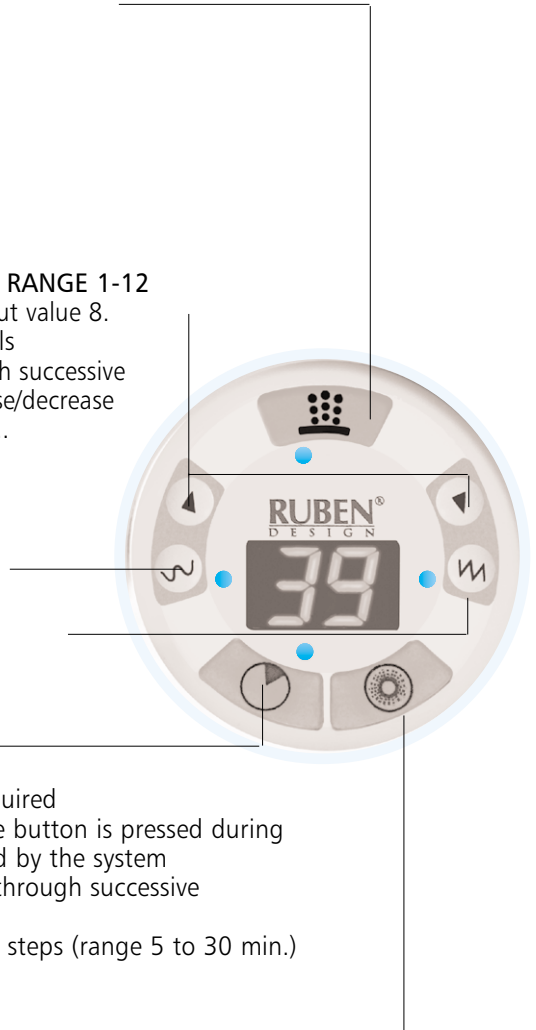

type maxus

RUBEN-MAXUSDIGITAL

PROwellness PROGRAMME
DISPLAY

DISINFECTION

PROwellness PROGRAMME
SELECTION

PUMP INTERVAL
WORKING MODE

PUMP OUTPUT
INCREASE

PUMP
ON/OFF
(water massage)

DISPLAY
(water temperature,
time, pump output -
with a dot
in left-hand upper
corner, sinusoidal/
pulsating mode)

PUMP OUTPUT
DECREASE

PUMP SINUSOIDAL
WORKING MODE

REAL-TIME SETUP
ACTIVATION

MODE BUTTON
(for setting up: hours,
minutes, temperature,
timer, light intensity)

UNDERWATER LIGHT

DRYING

PROwellness PROGRAMMES
ON/OFF

BLOWER INTERVAL
WORKING MODE

BLOWER OUTPUT
INCREASE

BLOWER ON/OFF
(air massage)

DISPLAY:
(water temperature,
time, pump output -
with a dot
in left-hand upper
corner, sinusoidal/
pulsating mode)

BLOWER OUTPUT
DECREASE

BLOWER SINUSOIDAL
WORKING MODE

TIMER SETUP
ACTIVATION

WATER HEATER ON/OFF



RUBEN[®]
DESIGN

MAXUS digital

Ultramodern, exclusive hydromassage system providing maximum comfort combined with therapeutic effectiveness enhanced by unique sensual and aesthetic experience.



RUBEN-MAXUS *Champagne*



CHAMPAGNE HYDROMASSAGE SYSTEM

is activated by turning on the pump and the blower and directing water stream on to the system of champagne jets.

ATTENTION: *massage intensity can be controlled by 4 adjustable side Max-jets.*

champagne jets

champagne jets
shiatsu jets
foot massage jets

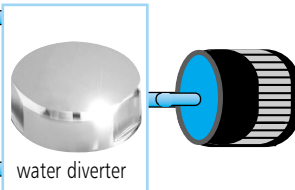

PROwellness PROGRAMMES

1. **Wimbledon** - medium intensity pulsating action from side jets alternately with air massage.
Water temperature: from tepid to warm
2. **Alaska** - short, high intensity massage in cool water for stimulating respiratory and circulatory systems.
Hardens the body, temperature 33°C
3. **Serengetti** - warm water and air massage alternately. Intensity from medium to high -
shoulders and spine prophylaxis.
4. **Laguna** - alternate air and water pulsating massage from low to high intensity. Relaxing in 36°C.
5. **Tsunami** - 15-minute warm pearl bath plus short water massage.
Relaxes away the stress and strain of a hard day. 37°C
6. **Tokyo** - from highly intense pulsating action of air and water systems to a soft sinusoidal pearl bath
in warm water - stimulating. 36°C
7. **You-Young** - for eternally young. Air pulsation alternate with pulsating waves
coming from the jets. Rejuvenates, promotes relaxed body and mind. 35°C
8. **d** - disinfecting programme

SYSTEM ACTIVATION; On powering on the diodes and display start glowing and in the lower corner of the display (on the left) a blinking dot appears. Filling unit with water activates the bottom and then the upper water-level sensors. Brightening up of system diodes signals readiness of the system to work - water temperature is shown and bath duration can be set up. A short press on time setup button causes real-time to be displayed for 5 secs. When symbol P lights up the system is ready for operation.



1. PROwellness PROGRAMME SELECTION

■ **short press;** a selection of one of 7 available programmes *or* disinfection



2. PROwellness PROGRAMME DISPLAY

Symbol P – selection of one of 7 available hydrotherapy programmes (symbol P informs about possibility of selection also during manual operation)

Digits 1-7 – selected PROwellness programme

Symbol d – selection of disinfection programme

Symbol L – manual light adjustment

Digits 1-9 – brightness control and pulsating light switch (*blinking*) with selected values displayed on screen

Symbol u – pulsating light activated



3. PROwellness PROGRAMMES SELECTION BUTTON

■ **short press;** a selection of one of 7 available hydrotherapy programmes *or* disinfection



4. PUMP/BLOWER INTERVAL MODE BUTTON

■ **short press;** *on/off*, work is signalled by blinking system diode with 1s frequency (0,5s lighting up/0,5s fading)

■ **hold down >3 secs.:** interval massage intensity setup signalled by blinking digits on display (bottom left for water system, bottom right for air system). The readout shows the last set value or average value (digit 4). To set up use button MODE (available range 2-6).

To accept selection **hold down the button** or the system will do it **automatically** after 5s.



5. PUMP/BLOWER OUTPUT INCREASE

Range 1-12, 1st press shows selected output, a dot lights up in bottom left corner of temperature display section of water system and timer display section of air system. The selected values appear for 4s respectively for both systems in lower sections of the display.

■ **short press;** pump/blower output increase.

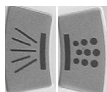

6. ON/OFF BUTTON FOR PUMP (WATER SYSTEM) AND BLOWER (AIR SYSTEM/CHAMPAGNE MASSAGE)

■ **short press;** system *on/off*. Medium output. After switching on the diodes are lit with dim light. Once the bottom water-level sensor (for water system) and upper water-level sensor (for air system) are activated the diodes brighten up.



7. PUMP/BLOWER OUTPUT DECREASE

Range 1-12, 1st press shows selected output, a dot lights up in bottom left corner of temperature display section of water system and timer display section of air system. The selected values appear for 4s respectively for both systems in lower sections of the display.

■ **short press;** pump/blower output decrease.



8. PUMP/BLOWER SINUSOIDAL MODE

■ **short press;** *on/off*, work is signalled by slow blinking of the system diode with 3s frequency. (1,5s lighting up/1,5s fading)

■ **hold down >3 secs;** sinusoidal massage intensity setup, signalled by blinking digits on the display (bottom left for water system, bottom right for air system).

The digits display the last selected value or an average value (digit 4).

To set up use button MODE (available range 2-6)

To accept selection **hold down the button** or the system will do it **automatically** after 5s.



9. **DISPLAY:** BATH DURATION (TIMER), **MINUTES OF REAL TIME** (WITH BLINKING DOT IN BOTTOM RIGHT CORNER), BLOWER OUTPUT (WITH BLINKING DOT IN BOTTOM LEFT CORNER), SINUSOIDAL/INTERVAL AMPLITUDE



10. **DISPLAY:** WATER TEMPERATURE, **HOURS OF REAL TIME** PUMP OUTPUT (WITH BLINKING DOT IN UPPER LEFT CORNER), SINUSOIDAL/INTERVAL AMPLITUDE



11. MODE BUTTON

- **short press;** values increase/decrease: minutes, hours of real time, bath duration, temperature, sinusoidal/interval amplitude, light intensity



12. BATH DURATION SETUP (TIMER)

- **hold down >3 secs.;** timer setup activation signalled by blinking timer screen. Desired time duration - button MODE. To accept selection **hold down >3 secs.** or system will do it **automatically after 5 secs.**



13. WATER HEATER ON/OFF (THERMOSTAT)

Ready after full system activation (symbol P on the upper screen)

- **short press;** heater *on/off* signalled by brightly lit diode and presentation of selected water temperature on display.
- **hold down >3 secs.;** thermostat setup signalled by blinking of temperature display. Selection of desired water temperature - button MODE. To accept selection **hold down >3 secs.** or system will do it **automatically after 5 secs.**



14. REAL-TIME SETUP

- **hold down >3 secs.;** real-time setup mode signalled by blinking time display. Hours setup - button MODE, then **short press;** minutes setup signalled by blinking minutes display. Minutes setup - button MODE. To accept selection again **hold down >3 secs.** or system will do it **automatically after 5 secs.**
- **short press;** real-time readout



15. DRYER BUTTON

- **hold down >3 secs.;** (when Maxus is de-activated) drying *on* diode blinking - stand-by mode, continuous light - function activated
- **short press;** function *off*



16. DISINFECTION BUTTON

- **hold down >3 secs.;** (when Maxus is de-activated) disinfection *on* diode blinking - stand-by mode, continuous light - function activated
- **short press;** function *off*



17. UNDERWATER LIGHT BUTTON

- **short press;** *on/off*
- **hold down >3 secs.;** light intensity adjustment signalled by symbol L on upper display, button released - current intensity readout Intensity adjustment - button MODE. To accept selection **hold down >3 secs.** or system will do it **automatically after 5 secs.** After accepting selection the upper display starts pulsating - now it is possible to switch on light pulsating mode by simultaneous pressing down MODE buttons. To accept selection **hold down >3 secs.** or system will do it **automatically after 5 secs.**

REPAIRS

Date		Repair No	short description	Repaired by (signature)
Accepted	Repaired			

Ruben Design will not hold responsibility for printing errors and reserves the right for alterations without prior notice.